

# Complete Streets

a guide for Vermont communities

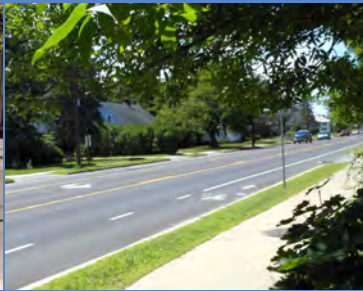

## Acknowledgments

This document was made possible thanks to the Vermont Department of Health's Fit and Healthy Vermonters Program, with special thanks to the following, who offered technical expertise and oversight of the project:

**AARP Vermont**

**Chittenden County Regional Planning Commission**

**Vermont Department of Economic, Housing and Community Development**

**Vermont Department of Transportation**

**Vermont League of Cities and Towns**

This publication was developed by Lucy Gibson, P.E., of DuBois & King Consulting Engineers, with Michael Oman of Oman Analytics and Kathleen Ryan-Landscape Architect with support by Grant/Cooperative Agreement Number 3U58DP001994-O1S2, from the Centers for Disease Control and Prevention American Recovery and Reinvestment Act. The views expressed do not necessarily reflect the official policies of the Department of Health and Human Services, nor does the mention of trade names, commercial practices or organizations imply endorsement by the U.S. Government.



September 2012

# Contents

- What Are Complete Streets?..... 1
  - Act 34: Municipal Requirements Under the Act..... 1
  - Why Complete Streets?..... 2
  - Vermont Examples..... 2
  - Opportunities for Achieving Complete Streets..... 4
- Complete Streets Planning and Design..... 5
  - 1) Determine the Land Use and Transportation Context ..... 5
  - 2) Determine Potential Users ..... 9
  - 3) Assess the Transportation Facilities..... 9
  - 4) Issues Beyond the Roadway ..... 12
  - 5) Select Complete Street Tools..... 13
  - 6) Consideration of Cost versus Need and Probable Use..... 30
  - 7) Documentation, Reporting and Maintenance..... 33
- Complete Streets References..... 34
- Performance Measures .....A-1
- Maintenance.....A-2
- Reporting Forms .....A-3



# What Are Complete Streets?

Complete Streets is a philosophy and approach to planning, design, construction and maintenance of our roadway network to consider all users, including pedestrians, bicyclists and transit riders. Context and current or potential travel patterns need to be considered in determining the appropriate way to meet the needs of all modes of transportation. Not every street or road will be used by a wide variety of modes, but a complete streets approach considers all users, and seeks desirable, practical and affordable improvements that will be accepted by the community. A Complete Streets project does not need to be all or none incremental improvements may contribute meaningfully to a multi-modal system.

The [Complete Streets](#) approach to planning and engineering has arisen after many decades where automobiles were the primary, and sometimes the only, mode of transportation considered in the design process. In the past 10 or more years, there has been a steady shift toward a more comprehensive view of the users that should be considered in the planning and design of transportation networks. In 2005, the [National Complete Streets Coalition](#) was established, which serves as an advocate for communities and states to adopt complete streets policies, and as a clearinghouse for information. This work has been further supported by the American Association of Retired Persons ([AARP](#)).

## Act 34: Municipal Requirements Under the Act

A complete streets policy for Vermont is implemented by [Act 34](#) of the 2011 Legislature: *An act relating to a transportation policy that considers all users.* The following is from the bill's text (Act 34, Section 1):

*The purpose of this bill is to ensure that the needs of all users of Vermont's transportation system—including motorists, bicyclists, public transportation users, and pedestrians of all ages and abilities—are considered in all state and municipally managed transportation projects and project phases, including planning, development, construction, and maintenance, except in the case of projects or project components involving unpaved highways. These "complete streets" principles shall be integral to the transportation policy of Vermont.*

*All levels of government are subject to the provisions of the act, and the following outlines the specific requirements for municipalities:*

### 19 V.S.A. § 309d. POLICY FOR MUNICIPALLY MANAGED TRANSPORTATION

*Except in the case of projects or project components involving unpaved highways, for all transportation projects and project phases managed by a municipality, including planning, development, construction, or maintenance, it is the policy of this state for municipalities to consider "complete streets" principles, which are principles of safety and accommodation of all transportation system users, regardless of age, ability, or modal preference.*

*If, after the consideration required under this section, a project does not incorporate complete streets principles, the municipality managing the project shall make a written determination, supported by documentation and available for public inspection at the office of the municipal clerk and at the agency of transportation, that one or more of the following circumstances exist:*

- 1) *Use of the transportation facility by pedestrians, bicyclists, or other users is prohibited by law.*

- 2) *The cost of incorporating complete streets principles is disproportionate to the need or probable use as determined by factors such as land use, current and projected user volumes, population density, crash data, historic and natural resource constraints, and maintenance requirements. The municipality shall consult local and regional plans, as appropriate, in assessing these and any other relevant factors.*
- 3) *Incorporating complete streets principles is outside the scope of a project because of its very nature. The written determination required by subsection (a) of this section shall be final and shall not be subject to appeal or further review.*

The Vermont Agency of Transportation (VTTrans) has identified the following types of projects as being outside the scope of Complete Streets (item 3 above) in their [guidance](#) on Act 34, which primarily includes maintenance activities (not a complete list):

- Crack sealing
- Culvert replacement
- Emergency repairs
- Guardrail replacement
- High risk rural road (HRRR) projects
- Ledge/slope projects
- Pothole repair
- Preventative maintenance, bridge maintenance projects
- Projects with pre-approved scopes of work (i.e., grant funded projects)
- Roadside mowing
- Road/shoulder sweeping
- Shim/leveling projects
- Sign replacement

## Why Complete Streets?

Complete Streets projects can provide diverse and widespread benefits, including the following:

- Streets that accommodate all users are safer for everyone, including automobile drivers and passengers. For example, everyone on the road is put at risk when a driver must cross the center line to avoid a collision with a bicycle or pedestrian, especially on a narrow road with restricted sight distance.
- Complete Streets can provide greater mobility and accessibility to those without a car. This can be particularly important to the quality of life for seniors and young people, allowing for greater opportunities to participate in constructive social and educational activities.
- Complete streets can offer a choice for less costly modes of transportation, which has economic benefit to individuals or families.
- Active travel (walking and bicycling) can improve health and provide needed daily exercise.
- It is more efficient to accommodate all modes at the planning and design stage, rather than retrofit after the fact, and correct safety issues for non-automobile road users.

## Vermont Examples

While Act 34 was passed in the 2011 legislative session, the concept of complete streets is not new to Vermont. VTTrans, as well as many communities throughout the state, have been following Complete Streets principles in many transportation projects. The following are just a few examples.



### Burlington: Transportation Plan and Street Design Guidelines

The City of Burlington has identified a plan for a network of complete streets in the city, and established design criteria for them in a set of Street Design Guidelines. The illustration to the right shows the features of a complete street, which is a conversion for Colchester Avenue from a four lane auto-oriented street to a three lane Complete Street. See the [Burlington Transportation Plan](#) for more information.



### Waterbury-Main Street/Route 2: Reconstruction of Street with streetscape improvements

Waterbury's Main Street is undergoing a major street reconstruction project. The results, currently in the final design phase, will include wider sidewalks, on-street parking, tree plantings, pedestrian-scaled lighting, bulb-outs at pedestrian crossings, and shared lanes for bicycles.



### Jericho-Main Street: Streetscape and Sidewalk

The Town of Jericho has constructed streetscape improvements that include sidewalks, lighting, and landscaping with a design that is appropriate for small village center.



### Cornwall-Route 30: Rural Pedestrian Shoulder Treatment

Route 30 in Cornwall, just outside of Middlebury, provides a scenic route for local walking. However, the road did not provide any shoulder room for pedestrians. While the traffic volumes on this route are not especially high, the rural high speed nature of the traffic created a hazard for pedestrians. Recent improvements have added a shoulder for walking, an appropriate design for a rural setting, and much less costly than a sidewalk.



### Norwich-Route 10A Corridor: Reallocation of Right of Way

Route 10A between Hanover and Norwich is a multimodal corridor, with vehicles, bicycles and pedestrians regularly commuting between the two communities. A VTrans resurfacing project provided an opportunity to reconfigure the corridor, converting two eastbound lanes to one travel lane and one bicycle lane. The new configuration was tested during the temporary restriping of the first layer of new pavement, allowing monitoring and adjustments to the design before the final striping.



### Burlington-Riverside Avenue: Street with Sidewalk, Bicycle lanes and Parallel Multiuse Path

This street passes through very diverse urban neighborhoods in Burlington, and is also a major traffic route connecting northern Burlington with Winooski. Recent reconstruction of this route included a sidewalk on one side, bicycle lanes along the street, and a multi-use path on the other side. In this way, many types of bicyclists are now served on the corridor. Lighting and crosswalks are provided as needed.



## Opportunities for Achieving Complete Streets

There are a number of implementation opportunities for developing a “complete” transportation system. The most common are VTrans grants that are targeted to bicycle and pedestrian improvements, such as the “Transportation Alternatives” federal funding program, established in the 2012 federal transportation funding legislation. There are also opportunities to piggyback the improvements onto other projects or activities, such as:

- Major utilities work, such as sewer, storm drain, or water projects often involve major excavation of a street, and create an opportunity to rebuild it in a manner consistent with complete streets principles.
- Resurfacing projects provide an opportunity to review items, such as lane width and striping, to provide for bicycles, or sometimes pedestrians. Shoulder widths may be extended, and drainage structures that may pose a hazard to bicycles can be replaced.
- Subdivision and site development projects often include constructing access and modifications to public roadways, which should be compatible with complete streets principles. Subdivision and zoning regulations can also require complete streets considerations, such as non-motorized connectivity requirements or consideration of the impact of a proposed development on non-motorized travel conditions.



# Complete Streets Planning and Design

Generally, most transportation projects that use state or federal funds must adhere to the [VTrans Project Development Process](#) or the [Local Transportation Facilities](#) guide for municipally managed projects. Both of these begin with the development of a purpose and need statement, which describes the entire rationale for the project and identifies the deficiencies it is intended to correct and the outcomes desired. VTrans states:

*Purpose and Need Statements (P&N) are the backbone of our work. They are the crux of the Project Definition Phase. The P&N needs to be written to state the problems of the transportation facility and the goal for that facility. A Purpose and Need Statement should not describe the author's recommended solution. The reader should be presented with sufficient material to understand the needs and goals of the project and then logically reach the same conclusion reached during the Project Definition Phase.*

The *purpose* of a project may be thought of as the goals that it seeks to realize, such as improvements to safety, mobility, accessibility (including non-vehicular), economic development or the aesthetic enhancement.

The *need* for the project consists of one or more identified circumstances that can be localized in the project area and fail to realize the identified goal(s).

Complete Streets principles require that the purpose and need statement include the perspectives of all users and modes. For example, purposes that embody complete streets might include:

- address safety concerns for all users including pedestrians and bicyclists
- provide safe routes to school for all users and modes
- serve places that generate high non-vehicular demand such as:
  - high density housing or commercial area
  - parks, playgrounds, museum or other civic, cultural or tourist attractions
  - college or university
  - concentrations of elderly, low income families or young children
  - established desire lines (per community input)
- improve ADA compliance
- complete or expand a pedestrian and bicycle network
- improve opportunities to reduce auto dependence
- set the stage for community goals such as higher density or mixed use development or downtown economic development

There are many approaches that can meet the goals of Act 34. The following are suggested as steps for implementing a complete streets plan or project design, which can be folded into the overall project development process.

## 1) Determine the Land Use and Transportation Context

Land use and transportation are inextricably linked. Land uses generate the need for travel and connectivity, and their arrangement dictates the possible means of travel. Compact settings, with a variety of land uses in close proximity and connected by streets that accommodate a variety of modes of travel, will have a higher portion of trips made by walking, biking or transit. Areas with more dispersed settlement patterns require longer trips, and will be more auto-dependent. An important first step in complete streets planning or design is determining the land uses and settlement patterns in the project area.



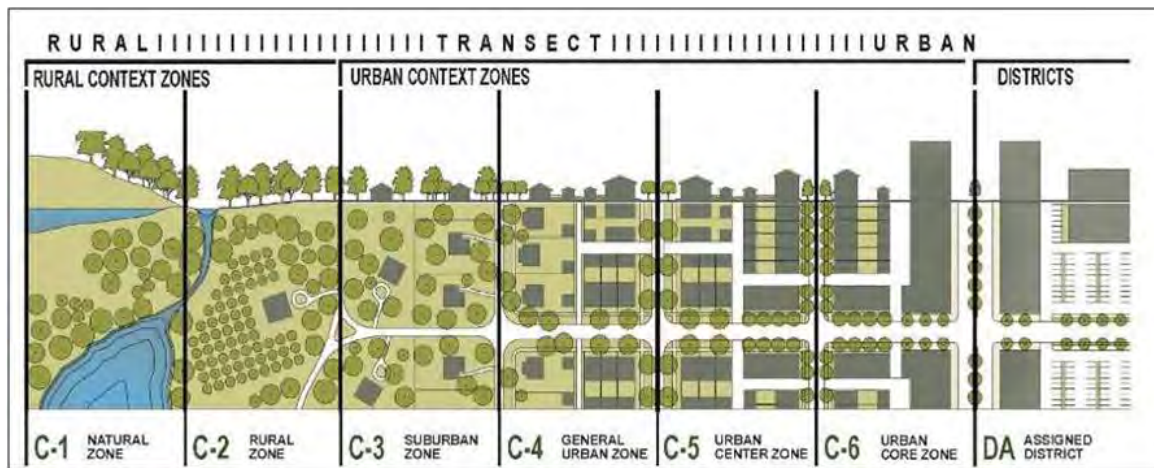

The need to consider the context in transportation design has long been recognized. The AASHTO “Green Book” includes only two place types, rural and urban. This is quite restrictive and doesn’t allow designs to be tailored to places that are in-between urban and rural or have more diverse characteristics. In the [Vermont State Design Standards](#) (VSDS), VTrans recognizes the need to design transportation projects to fit their context, and describes a variety of place types with different design considerations: city, village, suburban and rural.



Recently, the [Institute for Transportation Engineers](#) (ITE) has promoted using context zones, as defined in the “[Urban-to-Rural Transect](#),” as a tool to match transportation design with the context of a project location. The transect provides a graphical and intuitive way to understand and describe an area’s characteristics, and can also be linked to appropriate development and land use standards. The urban-to-rural transect is illustrated below.



The following table provides descriptions of the context zones adapted from [ITE](#), as well as comparable place types from the VSDS and Vermont places that exhibit these characteristics.

### Context Zones in Vermont

Context Zone	Distinguishing Characteristics General Character	VSDS Place Type	Representative Vermont Places	Photo Example (Randolph, Vermont except where noted)
<b>C1- Natural</b>	Natural landscape  Natural features	Rural	Smugglers Notch, Granville Gulf, Middlebury Gap, etc.	
<b>C2- Rural</b>	Agricultural with scattered development  Agricultural activity and natural features	Rural	Areas with a working landscape and low density settlement	
<b>C3- Suburban or Transition</b>	Single family residential with walkable development patterns, dominant landscape character  Detached buildings with landscaped yards	Suburban/ Transitional	Fringes of villages or downtowns, suburban areas	
<b>C4- General Urban</b>	Mix of housing types including attached units with a range of commercial and civic activity  Predominantly detached buildings, balance between landscape and buildings, presence of pedestrians	Hamlet or Village	Centers of Barnard, Jericho, Arlington, Putney, fringes of larger towns	

<b>C5- Urban Center</b>	<p>Attached housing types such as town houses and apartments mixed with retail, workplace and civic activities</p> <p>Predominantly attached buildings, landscaping with the public right-of-way, substantial pedestrian activity</p>	Downtown	Centers of Wilmington, Randolph, Middlebury, St. Johnsbury	
<b>C6- Urban Core</b>	<p>Highest intensity areas in the region with high density, high rise residential and workplace uses, entertainment, civic and cultural uses</p> <p>Attached buildings forming a sense of enclosure and continuous street wall. Landscaping within public right-of-way, highest pedestrian and transit activity</p>	City Center	Centers of Burlington (to right), Rutland	
<b>Districts</b>	Designated locally, districts are areas that are single-use or multi-use such as airports, business parks, universities or industrial areas	n/a	UVM, Middlebury, or other college campuses, Taft Corners Commercial Park, Putney Road, Shelburne Road, or other retail districts	

## 2) Determine Potential Users

In general, the context zone provides a general indication of the types of users and multimodal activity in a project area. The types of users and modes that would be most prevalent in different context zones are shown below. This is a generalization, and every specific site and location will have unique characteristics and uses different from that shown below.

User Type	C1	C2	C3	C4	C5	C6
<b>Pedestrians</b>						
▪ Lingerers/People Watchers					■	■
▪ Purposeful Walkers			■	■	■	■
▪ Recreational or Fitness Walkers	■	■				
<b>Bicyclists</b>						
▪ Fearless or Confident		■	■	■	■	■
▪ Less Experienced, Elderly or Young		■	■			
▪ Recreational Road Bikers	■	■	■	■	■	
▪ Mountain Bikers	■	■				
<b>Transit</b>						
▪ Paratransit Vans		■	■	■	■	■
▪ City Buses			■	■	■	■
▪ School Buses	■	■	■	■	■	■
<b>Other Vehicles</b>						
▪ Tractor Trailers	■	■	■	■	■	
▪ Delivery Trucks			■	■	■	■
▪ Emergency Vehicles	■	■	■	■	■	■
▪ Agricultural Vehicles		■				

Upon initiating a project, the following should be conducted to assure that all the potential users and beneficiaries of complete streets are considered in the design.

- Develop a map showing the places that are likely to generate non-automobile travel, or would benefit from improved conditions for biking and walking. These include schools, recreation areas, community centers, transit stops, park-and-ride lots, and senior or low income housing.
- Consult with local recreation committees or bike shops to identify popular local walking or riding loops.
- Consult the town plan or regional bicycle/pedestrian plan for any discussion on priority walking or biking routes, and locations where improvements are needed.

## 3) Assess the Transportation Facilities

The transportation facilities need to be evaluated for how well they are serving the appropriate range of users, and there are a variety of dimensions to consider, as discussed below.

### Functional Classification

The Functional Classification organizes the roadway network into Arterials, the primary routes for long distance travel; Collectors, serving intermediate length trips or feeding arterials; and local roads, which are intended primarily to provide access to land uses. In theory, this classification system narrowly describes the role of the road in terms of providing access to land (“to”) versus transportation mobility (“through”). In



practice, this system has limitations, as most roads provide a combination of “to and through” service that is simply recognized in the functional classifications system. For example, an arterial route may also be a “Main Street”, such as US Route 4 through Woodstock’s downtown. Route 4 is an economically important shopping district, provides a highly scenic public space, and is a route for all modes of travel. Combining the road’s functional class with the context zone provides a much more complete picture of the roles that a road plays in the community. An arterial route passing through a rural (C2) context zone is serving primarily a “through” function, while the same route passing through a village center or downtown (C4 or C5) provides a multitude of additional functions (economic, social, public space), and a good design will consider these specific needs.

### Roadway Surface

Act 34 does not apply to unpaved roads, which comprise over 45% of all road miles in Vermont. Unpaved roads are often appealing places to walk or bike due to the low volumes and speeds and scenic character. Because of these characteristics, they are exempt from the requirements of Act 34.

### Cross Section

The street cross section refers to the specific dimensions of the street components. The following example for St. Albans Main Street shows a broad urban street. Cross sections can vary widely along the length of a road or street, and also with the context they pass through. Understanding the current cross section as it relates to the public right-of-way is important for understanding possibilities for upgrades or improvement.

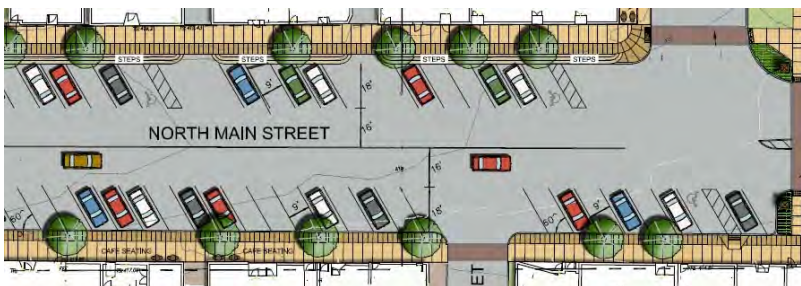
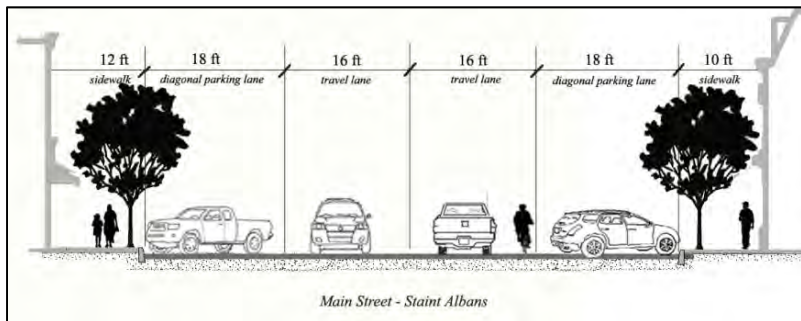



## Right-of-Way Width

The road or street right-of-way width is the area that the municipality or state has for transportation use, either by ownership or a permanent easement. The adjacent property owner may have use of the area that is not currently being used for transportation purposes, and many homeowners believe their front yards extend into the public right-of-way, as they may have been mowing and maintaining the area for years. Business owners believe the same about parking areas that may extend into the publicly owned right-of-way. Asking landowners to give up what they believe to be theirs in order to construct a sidewalk or bicycle lanes is among the most challenging situations that towns face when undertaking complete streets projects. Assuring that the design will be attractive and an asset to their neighborhood through context sensitive design, and incorporating design features that will enhance the neighborhood’s value, are among the measures that can help alleviate these concerns.

The most common right of way width for both town and state roads in Vermont is 3 rods, or 49.5 feet (one rod is 16.5 feet). Some roads have 4 rod right-of-way widths (66 feet), and along highways that have been significantly upgraded, or in the vicinity of interstate highway interchanges, right-of-way widths may be significantly greater. Information on roadway rights-of-way is typically available from municipal or state records. For state highways, the [VTrans Right-of-Way Section](#) may provide information for a specific location on a state highway. For town roads, the local records at the Town Clerk’s office specify the right-of-way widths.

## Traffic Speeds

For people walking and biking, traffic speed may be the single most important factor when traveling, for both perceived comfort and actual safety. High-speed traffic is fundamentally incompatible with safe and comfortable walking and biking along a road or street, whereas relatively high volumes can be tolerable if speed is low. [Research](#) in crash outcomes in relation to speeds shows that there is a drastically increased chance of a fatality for a pedestrian-vehicle crash as speeds increase (see chart). Keeping vehicle speeds at levels safe for pedestrians is a challenge, especially in rural areas, and usually requires a combination of enforcement and designing for a lower “target” speed.

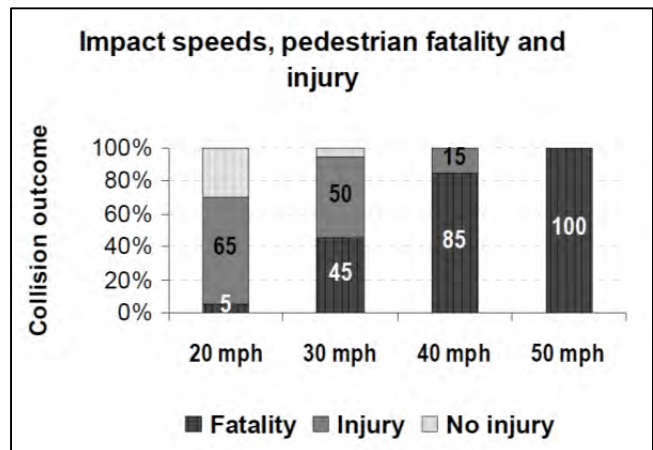

Posted speeds do not often reflect the actual travel speeds. Data on traffic speeds is useful in determining the existing environment for all road users, and one goal for a project may be to improve the pedestrian environment primarily through reducing traffic speeds.

## Traffic Volumes

Vehicle traffic volumes have an influence on pedestrian and bicycle safety, but less so than speed. For example, Main Street in Burlington is a high-volume street that is also great for walking and bicycling because the speeds are low to moderate. [VTrans](#) collects and maintains an excellent database of traffic counts on both state and local roads, which is published on their website. In addition, [Regional Planning Commissions](#) or Town officials may have useful traffic data. High volume roadways do not require high speeds to accommodate their flow. In fact, the most efficient speed for traffic flow is about 35 mph. A road designed for a slower and steady flow is safer for all users and less frustrating for drivers than a road designed for higher speed segments interrupted by traffic signals.

## Determine Crash History

An important component in understanding the current operations of a street is its crash history. VTrans maintains data of all reported crashes, and provides [listings](#) for both state and local roadways. In addition, the crash data is compiled to determine the locations in the state with the most frequent crashes, which can help to prioritize improvements. The VTrans database indicates if there were pedestrians or bicyclists involved the crash, which is particularly useful for complete streets planning.

## Assess Potential Bicycle and Pedestrian Hazards

An assessment of vehicle crash history might substantially under-report actual crashes and injuries involving bicyclists and pedestrians, as any crash not involving a motor vehicle (for example, a bicyclist who hits a pothole and flies over the handlebars) will not be reflected in this data set. It also fails to account for the “avoidance effect,” whereby few crashes involving pedestrians and bicyclists occur at a given location or along a given route simply because it is so dangerous that people on foot and on bike actively avoid it. Therefore, it is essential to go beyond vehicle crash history by evaluating road segments and intersections for conditions or facilities that have the potential to be hazardous for walking and biking. These include:

- Narrow lanes with no shoulders,
- High speed traffic (particularly if also high volume),
- Long crossing distances, or
- High turning volumes at a signalized intersection without a protected pedestrian phase.

The FHWA has developed [bicycle](#) and [pedestrian](#) road safety audits, which provide a prompt list for this type of evaluation. These lists need to be tailored to the context of the project under consideration.

## 4) Issues Beyond the Roadway

In addition to the context and transportation facilities, other factors will influence the best approach for complete streets, including the following.

### Environment

Environmental resources are always a critical consideration in any transportation improvement project. Resources could include wetlands, rivers and streams, critical habitats, and others. The [VTrans guide](#) for locally managed state or federally funded projects provides an excellent overview of environmental considerations in project planning and design. In general, environmental resource impacts should be avoided if possible. More information on the resource identification and permitting requirements can be found at the VTrans Local Transportation Facilities section.

### Economic Development

Economic development is frequently an underlying goal of many transportation projects, as transportation contributes significantly to community economic activity. Projects can range from expanding bridge capacity to accommodate larger trucks accessing an industrial area, to streetscape improvements to revitalize and attract visitors to a historic downtown.

Pedestrians generate a great deal of economic activity through shopping, dining, and accessing personal and professional services. An attractive pedestrian environment can facilitate economic activity in almost any location. Investments in complete streets also support economic development by promoting tourism and local shopping. Property values in neighborhoods with more walkable streets are typically higher.

## Placemaking

Public rights-of-way are important public spaces, particularly in village centers or downtowns. This is closely related to the economic development role of downtown streets, as an attractive Main Street that is an appealing place to linger will have more foot traffic in the retail spaces, and higher property values than one that is less alluring to pedestrians. There is a vast diversity of treatments from outdoor seating to public plazas to tree-lined sidewalks that are in fact all ways to bring people together, provide a place for social interaction, and foster the local economy.

## Aesthetics and Historic Resources

Vermonters and visitors alike value the scenic and historic character of our roads and villages. Sometimes there is resistance to projects with complete streets elements because neighbors may feel that the result is “too urban” or out of character with their community. In rural settings, there are concerns that widening a road to add shoulders for bicycling may have a negative visual impact, especially if trees or stone walls lining the road may be impacted. Federal laws protect these resources, and require that range of design alternatives with varying impacts are evaluated, and that impacts to historic and scenic resources be avoided if at all possible.

## 5) Select Complete Street Tools

In this section, a few general principles for complete streets planning are presented. Following that is information about specific components of complete streets, and further design considerations.

## General Planning and Design Principles

### Plan the network, not just the street

Effective transportation planning should take a network approach, and consider how a community’s system roads and streets can provide safe and comfortable movement for all users. For example, a low volume residential street that is parallel to a major corridor could be designated and designed as the primary bicycle route, and possibly avoid costly property acquisition on the main road.

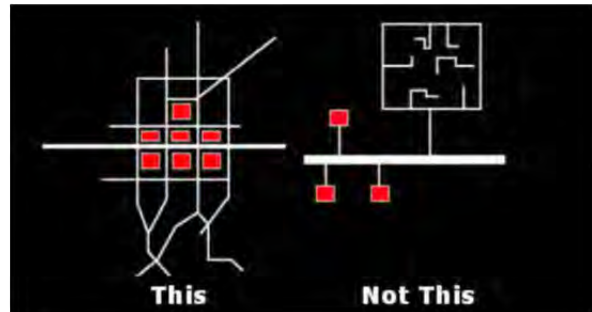

Connected street networks, with more frequently spaced streets and smaller blocks, support walkable and bikable development patterns. Efforts to establish or enhance connected street networks can advance the goals of complete streets. Highly connected street networks provide more direct routing for pedestrians and are associated with lower speed traffic, both of which can improve walkability. Such networks are also more robust, providing multiple routes between destinations, and are less susceptible to incident-based congestion.

There are often opportunities to improve the connectivity of a community’s transportation network through either land use planning or transportation plan development. Bicycle or pedestrian easements can sometimes be obtained to connect facilities and form a more direct and efficient network.

### Community Transportation Planning

Perhaps the single most useful tool in implementing a community complete streets strategy is a comprehensive community transportation plan, either as a stand-alone plan or as part of the community master planning process. A transportation element is required in a [municipal plan](#) under VSA chapter 117, and a context-based, complete streets approach provides a future transportation network that:

## Complete Streets: A Guide for Vermont Communities

- is designed to serve the desired land use context throughout the community,
- responds to the need for streets to support functions beyond transportation, such as placemaking or economic development, and
- provides balanced support for all modes and all users on a coherent, connected street network.

While the degree of specificity in the plan may vary widely, having such a plan in place offers several advantages:

- Street network connectivity can be planned as growth and development occurs, and tailored to the context zones that the community envisions.
- The issue of which streets should support which modes of transportation will be thought through, allowing investments to be made efficiently.
- Complete streets can be implemented incrementally, since the ultimate network will be understood and accepted in the plan.

In particular, bicycle facilities should be designed based on an overall plan that identifies how the bicycle network will connect key destinations within a community. The network may be built out with a variety of facility types best suited to the needs of potential users, environmental conditions and financial realities. For planning purposes, trips of 2 to 4 miles are considered ideal for bicycle trips. The following is an example of a bicycle network planning map of Hanover, NH, that shows the major destinations within bicycle distance that the planned network intends to connect.

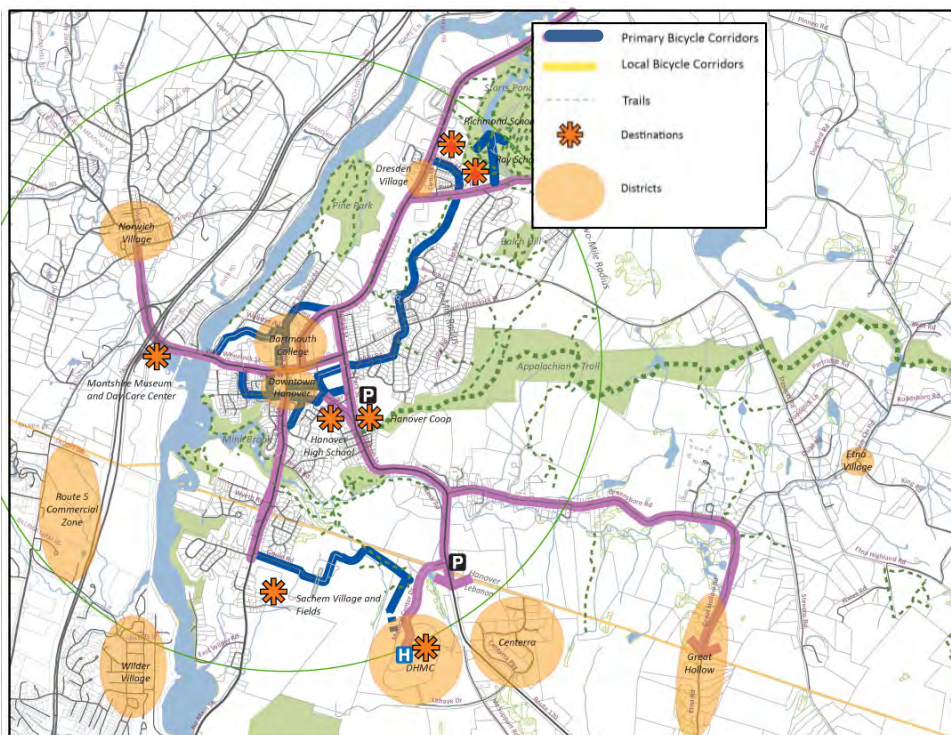

A fairly recent innovation in zoning the form-based codes is another tool for transportation network planning. Form-based codes typically include a thoroughfare plan that describes the function and desired context of each street, and may specify typical cross sections that should be considered as road improvements or land development occur. The thoroughfare plan, if followed over time, should result in a connected, complete streets network.



A Municipal Capital Plan is also of great value in implementing complete streets. Vermont Chapter 117 authorizes municipalities to develop and adopt six-year capital programs, as well as a one-year detailed capital budget. Investments in the community’s transportation infrastructure are important components of a capital plan, which allows the community to plan ahead for future expenditures in a rational fashion.

**Slow Down**

One of the most important things that can make streets safer for all users is to [manage traffic speeds](#). With careful planning and design, our roads and streets can be designed for a slower, steadier type of traffic flow that can be less frustrating for drivers, and safer for other modes of travel. Many tools described in this section may contribute to designing to achieve a lower or moderate speed that is more compatible with a complete streets approach. There is increasing awareness that there are [combinations of roadside design features](#) that can together influence drivers to slow down and be more cautious and expectant of pedestrians. The [Transportation Research Board](#) has a more detailed treatment of this concept.

The ITE has introduced the concept of a [target speed](#)—one that will work for all users—and the concept that we design the street to reinforce this speed, rather than design to accommodate the highest speeds prevailing on the road. The context and likely road users should be considered in evaluating an appropriate target speed for a road or street. In general, any areas where pedestrian travel is expected should be designed for 25 to 30 mph or lower.

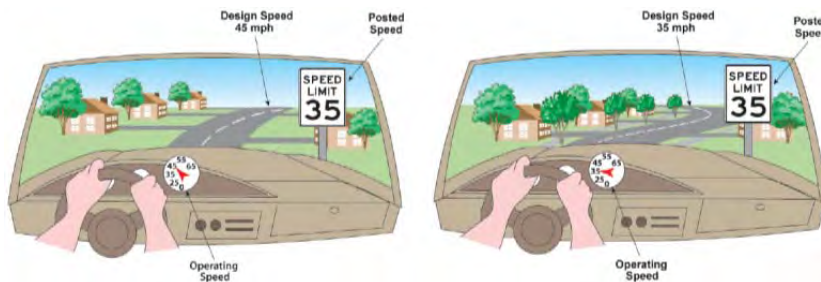

While design of streets can greatly influence traffic speeds, a long term commitment to enforcing speed limits is probably the single most effective means to improve safety for all road users, especially where existing facilities are inadequate to protect pedestrians or bicyclists from risks associated with high speed traffic. The benefits of designing for and enforcing lower speeds include:

- Pedestrians and bicycles are more visible because drivers have larger field of view at lower speeds.
- Drivers have more reaction time to avoid collisions, so everyone is safer.
- Crashes that do occur are less injurious at lower speeds.



40 mph                      30 mph                      20 mph                      15 mph  
*Clear field of view at different speeds (from Oregon Main Street Handbook)*

### Practice Context-Sensitive Design

As noted earlier, travel needs and patterns for all users are indicated both by the transportation network characteristic of a community plus the activities and patterns of development which can be described using the context zones. Designs proposed for a community should be compatible with both the setting and the transportation needs, and the following table describes some typical pedestrian and bicycle facility types that might be appropriate.

Context Zone	Typical Pedestrian Treatments	Typical Bicycle Treatments
C1 / C2	Shoulder Uncurbed sidewalk to specific pedestrian destination (i.e., school)	Shoulder Bicycle lane
C3	Uncurbed sidewalk Sidewalk with curb and green strip	Shoulder Bicycle Lanes Parallel Multiuse Path
C4	Uncurbed sidewalk Sidewalk with curb and greenbelt Urban sidewalk with tree wells	Shared Lane on slow street Bicycle Lanes Parallel Multiuse Path
C5	Wide sidewalk with curb and greenbelt Wide urban sidewalk with tree wells	Bicycle Lanes Shared Lane on slow street
C6	Wide urban sidewalk with tree wells	Shared Lane on slow street

### Components of Complete Streets

There are an infinite variety of potential design tools and strategies that can be used in complete street design. The following sections describe many that have been found useful in Vermont and similar areas, but are by no means the only options. In addition to the summary information provided in the following pages, references and examples are cited to provide more explanation.

#### Pedestrian Facilities

Although the complete streets philosophy is to accommodate all users, the pedestrian is perhaps the most fundamental. Essentially all trips by any mode, including the private auto or transit, must begin and end as a pedestrian. Pedestrians are the lifeblood of any vital downtown, and walking is an economical, equitable, environmentally friendly means of transport. Support for pedestrians is the core of a complete streets transportation strategy. The pedestrian environment consists of two essential elements: channels of movement (sidewalks) and street crossings.



#### Sidewalks

Sidewalks are critical components of the street and often are the principal ingredient of public space, especially in downtowns and village centers. To provide adequate space and a well-designed environment for



pedestrians, VTTrans suggests the following sidewalk width in different contexts in the Vermont State Design Standards (p.3-15):

**Sidewalk Width and Context Zones**

<b>5 ft</b>	Constrained situations, or rural areas with lower activity (C1-C3); ADAAG minimum width
<b>6-8 ft</b>	For local streets outside the central business district (C3)
<b>6-10 ft</b>	For commercial areas outside the central business district (C3-C4)
<b>8-10 ft</b>	For central business areas including downtowns and village centers (C5-C6)

Sidewalks in village centers and downtown areas are typically wider than in outlying areas. Especially in a central business district, a sidewalk should be thought of in three major zones, each of which serves a different function. These are:

1. **Fixture/furniture zone.** This is the area of the sidewalk adjacent to the parking or moving lane(s). It includes all features between these lane(s) and the pedestrian through zone. This area buffers pedestrians from the roadway and provides a place for trees, signal poles, signs, street lights, street furniture and fixtures, bicycle parking, and snow storage.
2. **Pedestrian through zone.** This is where most people walk. It should be clear of any obstructions or intrusions, permanent or temporary.
3. **Frontage zone.** This is the area between the pedestrian through zone and either the front wall of adjacent buildings or the edge of the right-of-way. In downtowns, it is where people window shop, enter and exit buildings, and sit or gather at outdoor cafes.

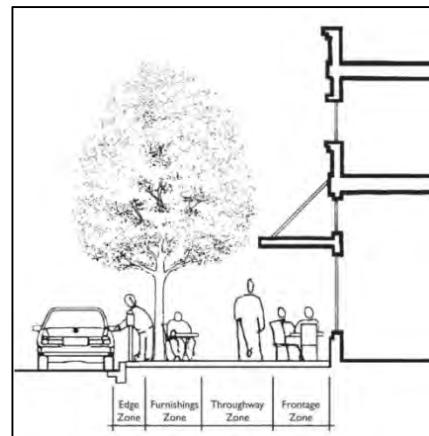

The figures to the right illustrate the sidewalk zones for a downtown or village center environment (C4-C6), as well as an example from Brattleboro where the zones are evident.

In constrained rights of way, which are typical in Vermont, it can be difficult to dedicate as much width to the sidewalk as will fully benefit a lively and vital downtown. However, it is not always necessary to fully contain the sidewalk area within the defined legal right-of-way. In some instances, it may be possible to expand the effective right-of-way for sidewalks with the municipality constructing and maintaining the sidewalks on the private property under covenant arrangement with the adjacent land owners. This can be especially beneficial if it is available to those abutters for seating, dining, or other activities related to the adjacent business. The example, which follows, is shown from the Newport City Thoroughfare Plan, which shows the sidewalk bleeding into private property frontage, but resulting in a more functional, attractive and vibrant pedestrian street.

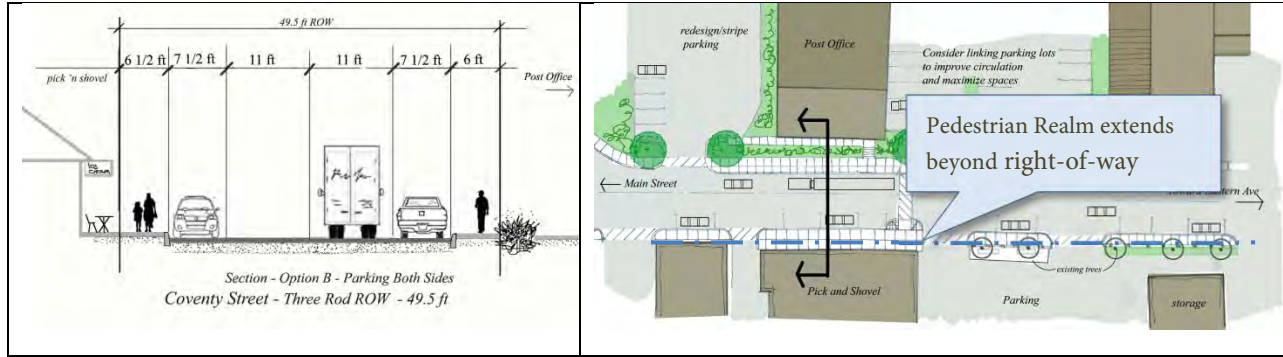

Sidewalks in rural and transition areas (C1-C3) that have less intense development will have a different look and feel, as well as different dimensions, than that of a downtown or village center. Cross sections can vary to include a curb, greenbelt, landscaped area, or drainage swale.

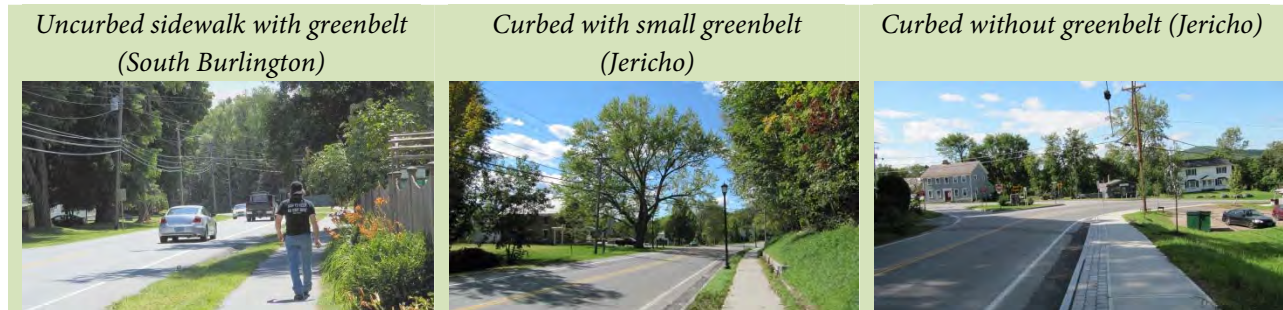

A sidewalk is not always appropriate in very rural areas, especially where road shoulders can provide a safe place to walk, or the speeds are low enough to safely share the travel lane. Vermont State Design Standards specify minimum lane and shoulder widths that depend on the road’s type and speed. Wider shoulders may not always be desirable, however, because they can have a modest effect of speeding up the traffic, plus they can impact a road’s scenic character.

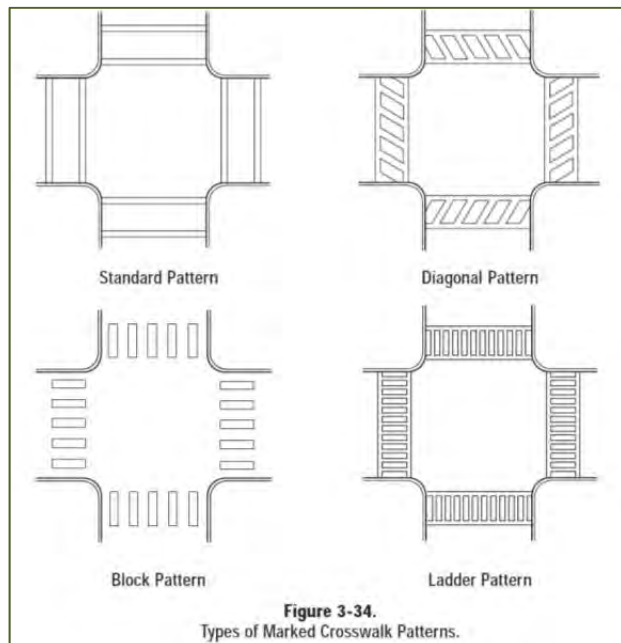

### Crosswalks

Marked crosswalks are most often located at intersections, and may be delineated by a variety of patterns. Vermont law grants pedestrians right of way at all marked crosswalks, unless they are controlled by a signal. Achieving this right of way is often something of a different matter, however.

VTrans looks for a minimum of 20 crossings per hour in the morning and afternoon peaks to permit a crosswalk on the State highway system. However, there can be some consideration for elderly or schoolchildren users, plus for potential crossings from existing uses that might generate more pedestrian traffic with a safer network, or from increased pedestrian traffic from planned development.

Sometimes the best location for a crosswalk is at a mid-block location rather than at an intersection. These crosswalks require additional signage and warning, as drivers may not expect pedestrians. Additional means to improve safety at pedestrian crossings include in-street stanchions to proclaim the pedestrian right of way, and devices such as pedestrian-activated rectangular rapidly flashing beacons (RRFBs), which have been found to significantly increase vehicles yielding to crossing pedestrians. Conditions at mid-block crossings can further be improved by the installation of curb bulbouts and/or median refuge islands. These shorten the overall crossing distance plus permit the crossing to be made in two steps for slower walkers.



*Median Refuge in Amherst, MA*



*Rapid Flashing Beacon in Hanover, NH*

ORW Landscape Architects and Planners

### Bicycle Facilities

There are a [variety of types of facilities](#) that can accommodate bicycles in our transportation networks, including the following.

Facility Type	Examples
Bicycle Paths	Multiuse paths, bicycle paths, cycle tracks
Bicycle Lanes	Bicycle lane adjacent to vehicle lane, can be separated from vehicle lanes by buffered zone
Bicycle Routes	Shared use of streets marked with Shared Lane symbols (sharrows)
Cycle Tracks	Two-way bicycle paths adjacent to streets, and physically separated from vehicle traffic.

Examples of the above facilities are shown in the following photographs.



*Bicycle Path in Newport City*



*Shared Lane Marking (Sharrow) in Burlington*





*Cycletrack in Montreal*



*Bicycle Lane in Montpelier*

**Shared lanes (sharrows)** are particularly appropriate in two circumstances: a) on low-speed, low-volume neighborhood streets that are designated as primary bicycle corridors, with speed humps and other controls to discourage vehicle through traffic; and b) in the downhill lane of a street that has a bicycle lane in the climbing direction, and where vehicle speeds are low enough that a typical downhill bicyclist will be traveling at the same speed as cars.

**Plain (unbuffered) bicycle lanes** are appropriate a variety of conditions, in particular: a) on streets with low speeds and moderate volumes (such as secondary city through streets); and b) on roads with higher speeds but low volumes (secondary rural and suburban roads). On high-speed, high-volume streets and roads, safety demands more separation from traffic.

**Buffered bicycle lanes** are preferred on any street that is appropriate for bicycle lanes and that: a) serves a disproportionate share of vulnerable users (in particular, along routes to school); or b) has higher traffic speed or volume than is ideal for a non-buffered lane, and where an additional measure of safety would make a big difference in terms of level of user comfort.

**Cycletracks** are appropriate on principal city streets that are key corridors for both bicycle and vehicle travel, and where speed, volume, and/or cross-section merit additional protection from vehicular traffic. They are particularly appropriate on streets where either of the following two circumstances apply: a) many fewer curb cuts exist on one side of the street than the other (with the cycletrack located on the side with few curb cuts so as to reduce conflict points); or b) a majority of origins and destinations are on one side of the street (with the cycletrack located on that side to reduce the need to cross the street). Cycletracks must be designed as a network, as managing the terminus of a cycletrack can be tricky due to the fact that bicyclists exiting the cycletrack will find themselves on the wrong side of the street.

**Separated paths** are very popular across a wide range of bicycling abilities. However, they have several important limitations that must be taken into account, in particular their high cost (especially if right-of-way or an easement must be acquired for the path), as well as the danger that a path with many vehicle crossings (driveways, cross streets, and so on) poses to bicyclists. Therefore, separated paths in developed areas are appropriate if both of the following conditions can be met: a) the path runs along a major corridor with high demand (actual or latent) for bicycle travel, but where on-road conditions are so dangerous that only a separated path can provide a reasonable degree of safety; and b) vehicle crossings of the path are relatively infrequent (the exact threshold will vary with the context, but between four and ten crossings per mile is a reasonable maximum). In rural or natural areas, separated paths are appropriate wherever: a) the path is likely to see significant recreational or transportation use; and b) there are few vehicle crossings.

## Transit

Transit service in Vermont is increasing due to several trends: rising gasoline prices, an aging population, and growing interest in environmentally sound travel choices. Complete Streets for transit will primarily focus on the transit stop design, and on the safe pedestrian environment in the vicinity of transit stops.

There are different levels of amenities for transit stops, ranging from a simple landing and sign to a “mobility hub,” which provides a comfortable shelter, route and schedule information, and other amenities. In general, stops should be designed to have a level of amenities consistent with demand and budget and always should have good pedestrian access. Most importantly, all bus stops should feel like an inviting and safe place to wait for the transit patrons, and unfortunately many bus stops fall short of this (see photo from Lebanon NH).

Bus stops may be simple curbside stops, or include either a bulb or a turnout stop if appropriate. In a turnout stop, a cutout is made into the sidewalk area for the bus to pull into. It supports continued traffic circulation past the bus when loading, but the bus must reenter traffic after each stop of this type. The bus bulbout has the sidewalk extended out to meet the bus, so that the bus stops without ever leaving its operating lane. Bus bulbs can allow for quicker boarding, and keep buses from being delayed by traffic. Bus turnouts can slow down bus service, and should be considered in locations where oncoming traffic speeds are high, or the population being served at that bus stop may take more time or assistance in boarding or alighting.



ORW Landscape Architects and Planners

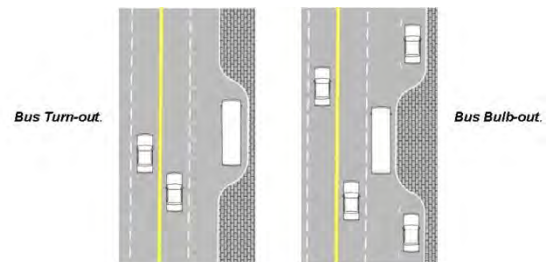

*Bus Pullout in Lebanon, NH*



*Bus Bulb in Hanover, NH*

Bicycle access to transit is an increasingly important way to increase the “user shed” of a transit stop. While walking trips to transit stops are typically ½ mile or less, bicycle access can increase the coverage of a transit stop to 2 miles or more. Many transit providers in Vermont now have bicycle racks, allowing bicycles to be transported with the passenger. Bus stops should also include bicycle parking. While bike racks are an appropriate form of bicycle parking in low-theft rural areas, bike lockers or other forms of secure bike parking are essential in more urban areas. A single automobile parking space can accommodate bike lockers for up to a dozen bikes, and revenue from coin-operated lockers can recoup a substantial portion of their installation cost.

## Design of Complete Streets for All Users

A complete street does not result from simply adding a sidewalk or a bike lane to a roadway, but requires additional design elements that together meet the goals of providing a safe and comfortable place for all users. This section reviews a variety of design tools to consider in a complete street design project. An example below of a project being designed for Waterbury, Vermont's Main Street shows a number of complete street features combined in one project design.

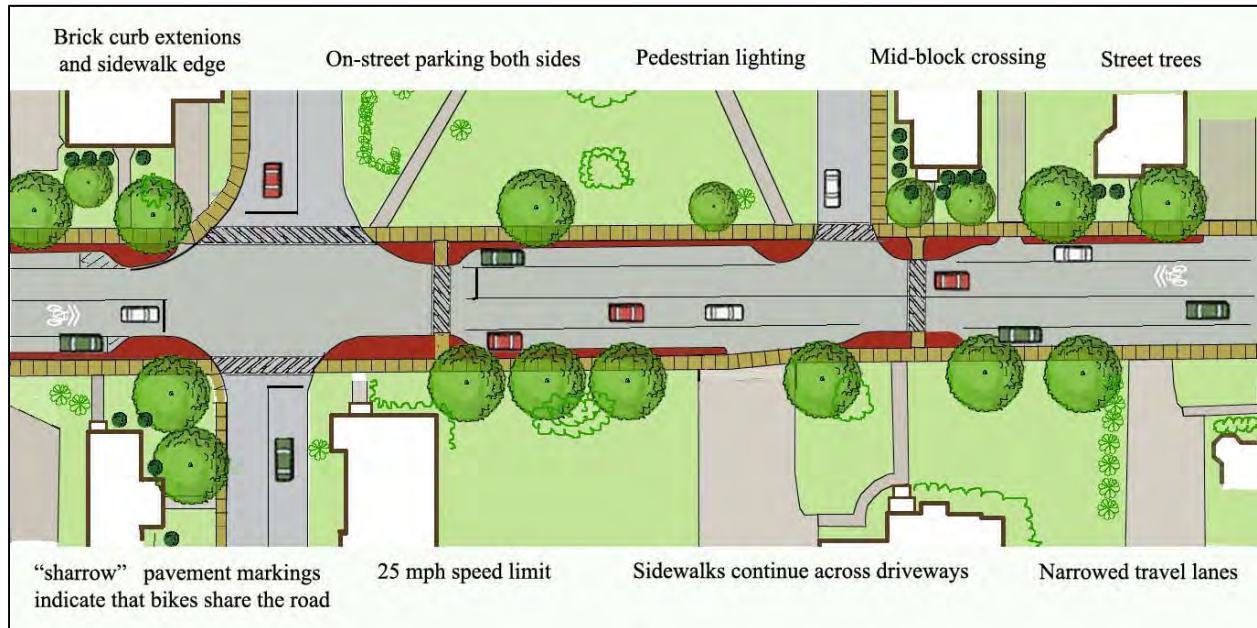

## Roadway Width

Recalibrating the balance between the motor vehicles and other users is a primary goal of complete streets, and it can sometimes be achieved simply through a reallocation of the right-of-way width. The benefits of narrower travel lanes on community streets are significant:

- More space within any given right of way for other non-vehicular modes and activities (including place making and parking);
- The streets are easier, safer, and faster to cross (crossing streets is often the single greatest impediment to good pedestrian circulation); and
- Vehicular traffic generally travels at lower speeds.

There are two levers by which the width of the vehicular way is modified: lane width and number of lanes.

## Lane width

In the past, it was fairly common to think of the “basic” traffic lane as 12 feet wide, and many of Vermont’s roads and streets have this lane width. However, this is the basic interstate lane, and is far more expansive than necessary in downtown and/or constrained conditions. Passenger cars are generally around 6 feet wide, and a typical tractor trailer is 8 feet 6 inches wide, so narrower lanes can provide more than adequate room for traffic, as long as the speeds are lower.



VTrans has established a range of acceptable lane widths for the local, collector, and minor arterial streets. They allow for 10- to 11-foot lanes under pretty much all urban, downtown or village conditions (i.e. C3-C6), and will accept 9-foot lanes on local streets. Rural roads typically require 11-foot lanes.

### Number of lanes

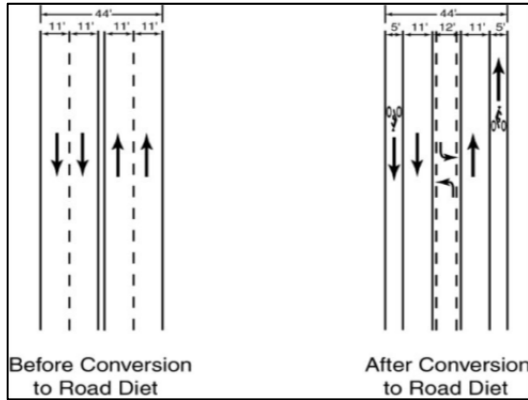

Most Vermont roads have two travel lanes, one in each direction. On roads with more than two lanes, consideration should be given to whether or not there could be fewer lanes. Several communities have recently “right-sized” their major thoroughfares to provide more room for non-auto users, without any unreasonable traffic congestion resulting. These reconfigurations, also called “road diets,” have been conducted on Williston Road in South Burlington, and Colchester Avenue in Burlington. Norwich has also reduced travel lanes on Route 10A to provide a much needed bicycle lane. The concept of a road diet is shown to the left.

### Streetscape Elements

The following elements form the pedestrian realm of the street, or streetscape.

#### Curbing

One important design consideration, especially in smaller towns, is whether or not to add curbing as part of a sidewalk project. Installing curbing to the side of the road can help define the edge of the vehicular way and provide the needed separation from the roadway for sidewalks that are close to the road edge. However, the installation of curbing can increase the sidewalk cost substantially, and also may require storm drainage facilities that would not be required for an uncurbed sidewalk.

#### Greenbelts

The grass strip located between the sidewalk and the roadway is typically referred to as the greenbelt. A greenbelt enhances a sidewalk by separating the pedestrian from the traffic and defining a distinct walking space. Where parallel parking is allowed and in demand, curbs will protect the greenbelt from being used for parking. Greenbelts are not always sustainable in downtowns with high turnover, on-street parking, as heavy foot traffic compacts the soil, but they can provide a place for snow storage in the winter.

#### Street Trees

Street trees separate the pedestrian from the traffic, provide shade in summer, support wildlife and mitigate stormwater impact. Trees add to the pedestrian experience and have



been shown to improve property values in both commercial and residential areas. Most importantly, roads bordered with street trees have been shown to reduce vehicle speeds thereby improving safety for all roadway users.

The selection, location and planting requirements are crucial for sustaining urban trees. Communities should consult a knowledgeable professional or the Vermont Urban and Community Forestry Program for assistance. Tree location should also consider the sight distance requirements at pedestrian crossings. VTrans has published a [landscape guide](#), which is an invaluable resource when considering tree planting in public road rights-of-way. A minimum of six foot greenbelt is required to sustain the root system of a street tree. Supplemental engineered soils under an adjacent sidewalk can be combined with greenbelt soil to provide additional root area for street trees.

### Lighting

Illumination is an especially important component of Complete Streets, as it can encourage walking and cycling into the evening hours. Illumination for sidewalks, crosswalks and bicycle lanes provides visibility of users' surroundings and also makes the pedestrian and cyclist more visible to drivers. Lighting, if done well, can enhance the nighttime environment and give users a greater sense of personal security. In addition, it has been demonstrated that when more people are out on the streets and sidewalks at night, rates of crime are actually reduced.

Illumination is especially important at intersections and mid-block pedestrian crossings. Roadway lighting should be designed to illuminate the pedestrian way as well as the roadway. Decorative and period lighting can be a welcome amenity to the pedestrian environment and can help define a town and village center. While the exterior of the fixture may be attractive, a well designed fixture should perform well when illuminated at night and control unpleasant glare. Illumination levels and color should be warm and welcoming and compatible with the ambient light from stores and other existing sources. Placement of light poles and fixtures should consider other elements of the streetscape, such as parked vehicles and street trees.

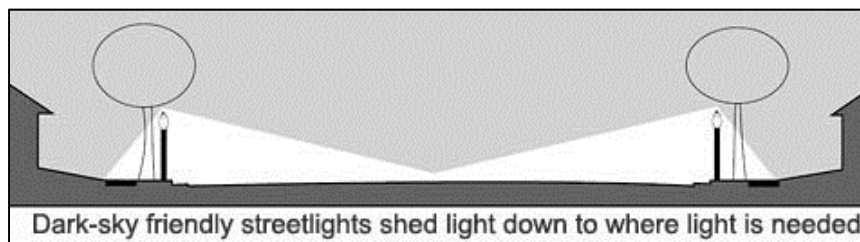

Lighting design is a complex combination of art and engineering that is ideally conducted by a professional. However, there are several guides and resources that provide a good background for municipalities that are considering lighting improvements. The [Outdoor Lighting Guide](#) covers many useful basics of lighting design. [Efficiency Vermont](#) can be a resource for up-to-date technical information and for information on rebates for replacement fixtures. The [IESNA](#) (Illuminating Engineering Society of North America) has several bulletins that address outdoor lighting and specifically roadway lighting.

### On-street Parking

On-street parking is a valuable resource for most downtown commercial areas, and for densely developed residential areas. The most common form of on-street parking is parallel parking along the edge of the roadway, which requires the least share of the right of way width, but also offers the lowest parking density. On-street parallel spaces are often specified as 8 feet wide. However, under more constrained conditions,

spaces 7 ½ feet wide can be considered. Bicycle operation in the vicinity of on-street parking can be perilous because of opening car doors.

Where available right-of-way permits and adjacent demand indicates, angle parking can provide higher parking density along the length of street than parallel, but also brings hazards to bicycles because of poor visibility when cars are backing up into the street. Especially on streets with bike lanes, “back-in” or reverse angle parking offers advantages in safety. Most angle parking mishaps occur upon backing out of the space into traffic, as the driver’s view is often blocked by an adjacent vehicle, endangering oncoming cyclists. In reverse angle parking, the backing up maneuver occurs from the street, where the driver has full view of oncoming traffic. Although the basic idea of backing into an angle space may seem complicated, parallel parking requires even more complex maneuvers.



In addition to providing access for commercial or residential areas, on-street parking can provide a positive barrier between active pedestrian areas on the sidewalk and the moving lanes of the street, and enhance the sense of safety and separation for the pedestrians.

A single car parking spot that is converted to a bike corral can provide parking for a dozen or more bikes. In core areas that are seeking to increase opportunities for people to come downtown to shop, carefully sited bike corrals can increase substantially the parking capacity of the area, thereby generating more shoppers without the need for extremely expensive construction of structured parking.



### Traffic Calming

[Traffic calming](#) generally refers to design measures that are primarily intended to reduce traffic speeds on a street or in a neighborhood. While lower speeds generally improve safety, the primary focus of traffic calming projects is often broader: to improve the quality of life, reduce noise impacts from high speed traffic, and deter vehicular traffic from using neighborhood streets. Some measures, such as curb extensions or roundabouts, are dual purpose in that they both reduce travel speeds and provide for increased intersection safety.

One application of traffic calming that may have applicability to Vermont town centers and villages located along rural high speed roads is to reinforce the transition to a lower speed limit through streetscape design features. The following graphic shows a transition scheme that includes landscaping, gateway signs, splitter islands and optical striping (a pavement marking to alert drivers to a reduce speed zone).

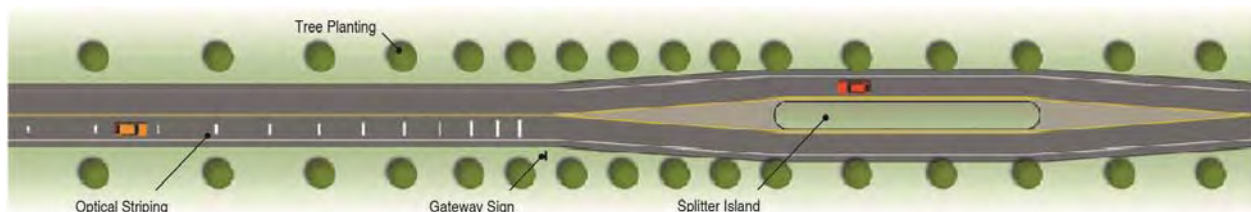

ORW Landscape Architects and Planners



### Considerations for Three Rod Roads (49.5 foot right-of-way)

The complete streets approach is intended to support all modes and users, and often results in shifting emphasis away from the motor vehicles, around which so much of our transport system has traditionally been laid out, toward pedestrians, bicycles and transit. In practice, much of the challenge of implementing complete streets in Vermont consists of allocating the public right of way among the competing demands. Probably the most common road right-of-way by mileage in Vermont is three rods (49.5 feet). From the viewpoint of providing multiple functions within the roadway right of way, this is very narrow, and it may be necessary to make compromises from the most desirable complete street dimensions. Some principles can be helpful in optimizing complete street functions within a constrained right-of-way:

**lane width:** A typical lane width is 11 feet, particularly in more built up village areas. However, 10-foot lanes are permitted by VTrans in many circumstances, including in heavily built up urban areas where truck traffic is low and on rural collectors with Annual Average Daily Traffic (AADT) of less than 2,000 vehicles per day.

**parking:** On-street parallel parking spaces are often marked to have an 8-foot width, however 7.5 feet is acceptable under constrained conditions. Widths of 7 feet may work as long as the travel lane is not also at the 10-foot minimum.

**greenbelt:** generally a 6 foot greenbelt is the minimum for trees. However with the use of modern engineered soils extending under paved areas, lower width may be achieved.

**sidewalk:** sidewalks require a minimum of 5 feet in width, and 6 to 8 feet are preferable.

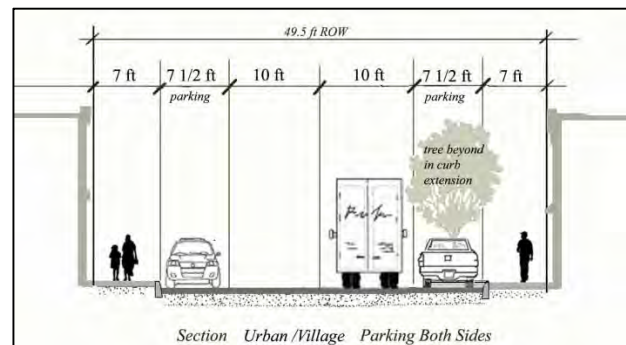
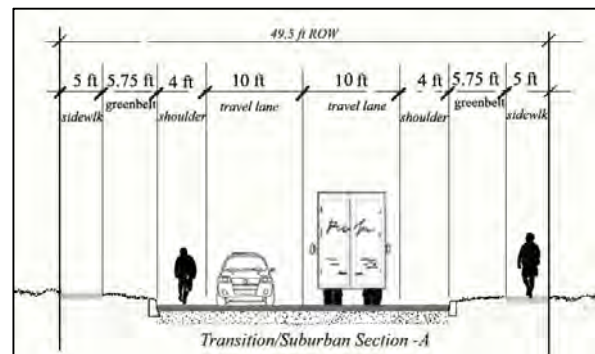
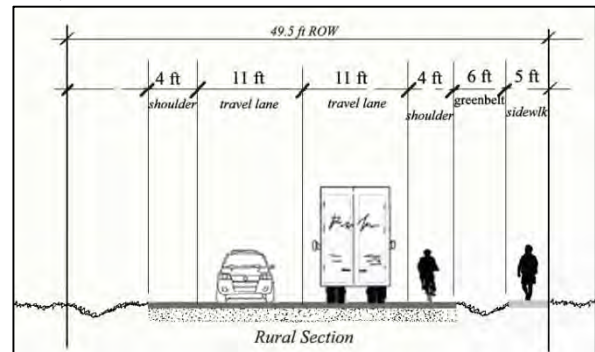

### Access Management

[Access management](#) is a traffic planning and engineering approach that addresses the interchange between the public roadway and the adjacent properties. In many Vermont towns and villages, parking areas often occupy the entire street frontage and may be served by multiple, or even continuous access driveways. In a few instances, parking is directly off the street with no defined



curb cut at all and the parking traffic backing directly into moving traffic and across the sidewalk, if one even exists. This kind of arrangement creates an environment that is unsafe, uninviting and difficult to navigate for pedestrians and bicyclists. (It is even unsafe and difficult for vehicular traffic, which was the initial impetus for developing approaches to deal with it.)

Access management generally strives to consolidate accesses to adjacent properties to limit their number and size, and turning movements are managed by means of medians or center turn lanes, or other means to reduce conflicts from traffic movements. By reducing the number and extent of vehicular crossings of the pedestrian and bicycle routes, access management is effective at enhancing the environment for these modes as well. The Vermont Ped Bike Manual includes a discussion of access management as it applies to pedestrian and bicycle issues in Vermont.

### Complete Intersections

Intersections are by far the largest source of both delay and safety issues for motor vehicles, but are also points of concentrated pedestrian and bicycle activity. Bicycle routes and travel lanes converge here, and pedestrians must cross the streets at these locations. Because of their relationship to the pedestrian circulation system, transit stops are often located at or near intersections. As a result, this is the area of greatest potential conflict between all road users. However, many improvements intended for more efficient vehicular operation make matters worse for pedestrians and bicyclists. The following provide some design issues to be considered in a complete intersection design.

### Design Vehicles

Because of the turning movements that occur at intersections, a first step in intersection design is to select the appropriate “[design vehicle](#)” and “[control vehicle](#).” The Design Vehicle would be the largest vehicle that regularly turns at the intersection, and therefore should be accommodated without encroachment into the opposing traffic lanes. The Control Vehicle is one that infrequently uses a facility and must be accommodated, but encroachment into the opposing traffic lanes, multiple-point turns, or minor encroachment into the roadside is acceptable. Examples of control vehicles would include tractor trailers or moving vans in a residential neighborhood, or emergency vehicles that may pass through, but rarely turn, at an intersection.

The following are some design tools that can result in a safe mix of different modes at intersections.

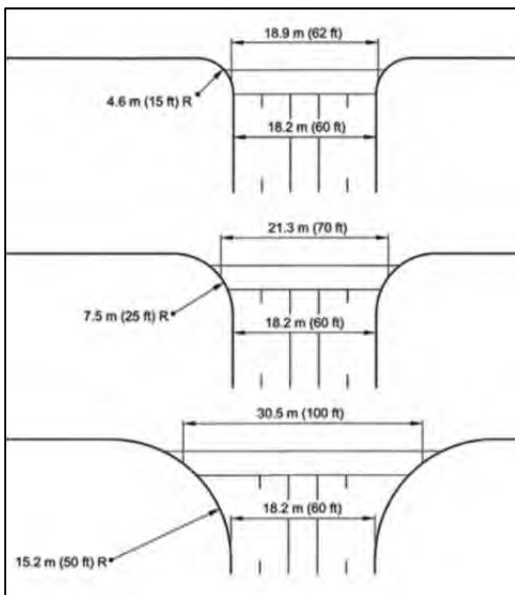

### Corner radii

Corner radii (sometimes called “curb return radii”) have typically been designed to provide easy, higher speed turning for cars, and to be large enough to accommodate larger trucks and allow them to stay completely in their lane. However, large curb radii can dramatically increase the crossing distance for pedestrians. As the figure on the left shows, a 50-foot curb radius can increase pedestrian crossing distance by as much as about 38 feet compared to a 15-foot curb radius. This can be wider than the street itself, and dramatically increase crossing time. At unsignalized intersections, this can hamper the ability of pedestrians to cross safely, and at signalized intersections it increases the time that must be taken from other movements. It also increases the speed of vehicular traffic, increasing the risk to all users.



Corner radii in downtown areas of 10 feet or less are far more practical for pedestrians. Crossings are shorter, speeds are lower, and ramps align with direction of travel. Furthermore, when in-street parking is present, the effective radius will be far greater as shown in the figure to the right. Even a 5-foot radius bracketed by 7½ foot parking lanes will have an effective 20 foot radius. While tight corner radii can result in occasional encroachment by larger vehicles, the trade-offs of pedestrian safety versus the amount of inconvenience caused by this encroachment should be considered. Also an important consideration is that overall safety is improved with the lower speed environment that is reinforced by tight corner radii, allowing drivers to more easily avoid any collisions if large vehicles do encroach into their lane. Other treatments can be considered for high truck volume areas, such as appropriately designed slip lanes.

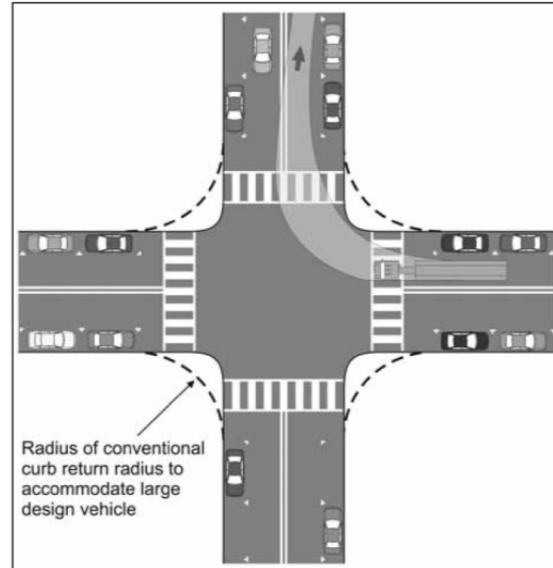

In general, curb radii should be kept to the minimum consistent with overall safety and operations. Curb radii in most core areas with high pedestrian demand in the range of 10 feet to 15 feet will work well and support most needs. Radii of as little as 5 feet may be acceptable if other factors increase the effective radius. Larger radii should be considered carefully and only implemented as requirements dictate.

### Corner Radii Guidelines

Condition	Preferred Radii
Default (P - Passenger Car is the Design Vehicle)	10 to 15 feet
Bicycle Lane or On-street Parking is Present	5 feet
Design Vehicle is Larger than Passenger Car (P)	15 to 40 feet

### Number and design of turn lanes

Auxiliary lanes for left and right turns are often added to an intersection to facilitate traffic flow. However, they should be used judiciously on complete streets. Each additional lane increases the distance and time to cross the street, so turn lanes should be added only where volumes and turning movements warrant them. Right turn lanes particularly should be restrained, as they can increase the speed of traffic flow, and by facilitating right turn on red movements, they can further degrade the crossing ability of pedestrians.

One ambivalent trade-off in this category is the right turn slip lane. It is particularly effective at increasing traffic speed and right-turn-on-red movements. However if appropriately designed, meeting the receiving street at a less acute angle to facilitate visibility and providing appropriate pedestrian links, it can also provide an effective refuge island supporting pedestrian access in the face of more challenging vehicular traffic demands. The figure to the right illustrates the difference between a wider angle that promotes

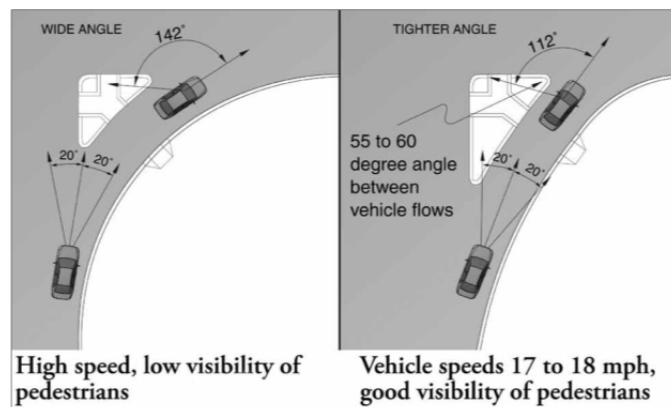

higher speeds and poor visibility of pedestrians (left side), and a tighter angle where speeds will be lower and pedestrian visibility increased.

**Curb extensions**

As in the case of mid-block crossings, pedestrian access at intersections can be enhanced by appropriate curb extensions. They reduce the crossing distance and time and provide for better pedestrian visibility of the street traffic. Where on-street parking is provided, curb extensions can restrain the parking from either blocking the visibility required by pedestrians or encroaching into the pedestrian crossing area. They can provide enhanced transit accessibility by making it easier to board and reducing dwell times during stops. They also provide additional sidewalk space for



furnishings, signage, or landscaping to enhance the street environment. The photo above shows curb extensions in Winooski, and the following graphic illustrates effect of curb extensions on crossing lengths.

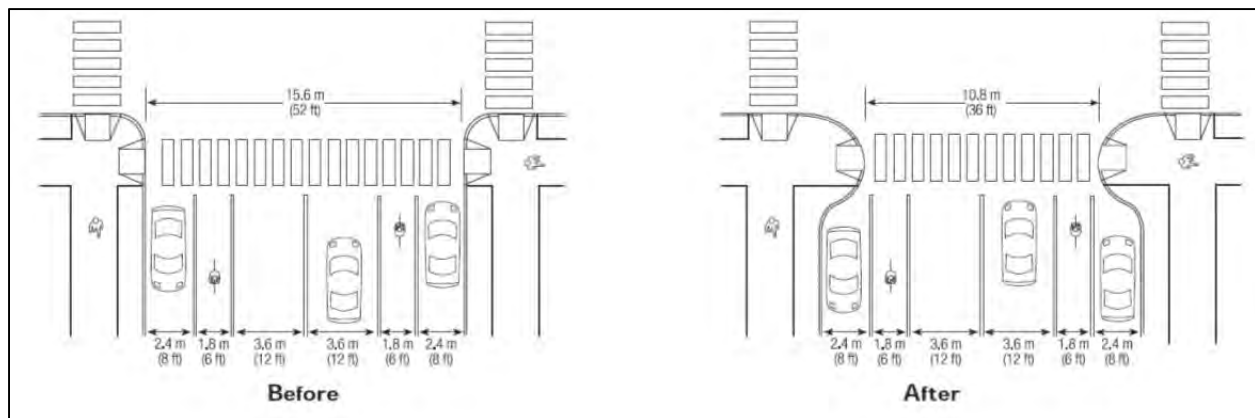

**Traffic signals**

Traffic control at intersections is often achieved by means of traffic signals. Probably the most important feature of traffic signals for complete streets is the incorporation of a properly designed pedestrian signals with countdown indicators and properly located, handicapped accessible push buttons. Beyond that, a number of considerations are appropriate:

- Timing to minimize conflicts for crossing pedestrians with turning vehicles,
- Short cycle lengths to minimize delays for waiting pedestrians,
- Signal coordination set to result in appropriate operating speeds along a corridor, and
- Leading pedestrian interval This is a signal timing plan for “concurrent” pedestrian operation where the pedestrians get a head start in crossing the street with a walk indicator. Vehicles get a green signal a few seconds later than the pedestrians, so that the pedestrians are well in the crosswalk and more visible to turning cars than they would be if still waiting at the corner.

### Modern roundabouts

Modern roundabouts are increasingly common in the Vermont transportation system, and can be an alternative to a traffic signal for an intersection that needs some type of control beyond stop signs. Because of their space demands, they are not often used in downtowns or locations with historic buildings near the intersection. Roundabouts are inherently safe for pedestrians and bicyclists. Crossings are limited to the outer circumference and do not cross the higher speed circulating roadway. Their slow speeds are the most important contribution to safety, and the built-in refuge islands are broadly compatible with pedestrian convenience and safety. The [FHWA](#) and the [New Hampshire DOT](#) both provide information on roundabouts at their websites.

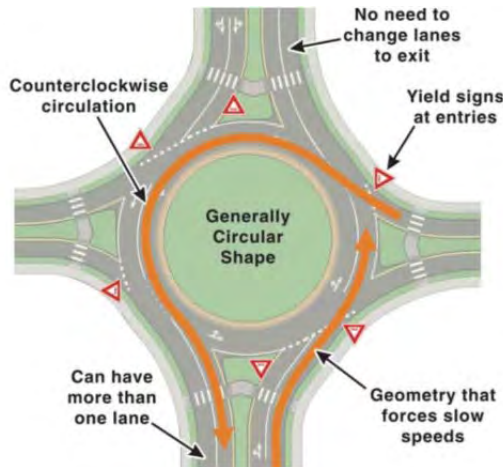

Features of a Modern Roundabout (FHWA)



Roundabout in Montpelier at US 2/US 302 intersection

### 6) Consideration of Cost versus Need and Probable Use

Transportation projects must weigh the cost of accommodating users in the safest way possible with the probable use and benefits. A few general considerations to weigh the cost, benefits, probable use, and need include the following:

- Areas that are more densely developed and have a mix of land uses will benefit most from complete streets investments.
- Roadways that have high speeds pose the greatest threat to the safety of pedestrians or bicyclists.
- There are many different ways to accommodate users. A good planning and design process will consider and evaluate a range of alternatives that vary in cost and complexity.

### Consider the Benefits

It is important to weigh the costs of completed streets improvements against their potential benefits. While it is impossible to fully quantify these benefits, an appreciation of their value is an important part of the evaluation of any complete streets project. Some helpful information is available at the [Victoria Transport Policy Institute](#), and is summarized in the following table.

### Benefits of Providing Walkable Streets

Benefit	Description
Accessibility	Degree that non-auto transport provides mobility options, particularly for people who are transportation disadvantaged.
Consumer cost savings	Degree to which non-auto transport provides consumer transportation cost savings, e. g., private vehicle ownership and operating cost, parking.
Public cost savings	Degree that non-auto transport substitutes for vehicle travel and reduces negative impacts, including externalities (e. g., air pollution, crashes, etc.).
Efficient land use	Degree that non-auto transport helps reduce the amount of land used for roadway and parking facilities and helps create more accessible, clustered land use.
Livability	Degree that non-auto transport improves the local environment, including property values, business activity, etc.
Public fitness and health	Degree that non-auto transport provides physical exercise to people who are otherwise sedentary.
Economic development	Degree to which non-auto transport makes commercial areas more attractive and shifts consumer expenditures to goods that provide more regional economic activity and employment (see discussion under “other considerations” above).
Equity	Degree that non-auto transport helps achieve equity among various user groups, especially the elderly, young, disabled and disadvantaged.

### Costs and Funding

It has been conventional practice to treat many of the multi-modal components of the transportation system as add-ons or extras, supplemental to the basic purpose of that system which was seen to be to move cars. Sidewalks and crossings and bike accommodations were often funded as “enhancements” to the “real” transportation system. Under Act 34, the multi-modal and universal access elements of street design are not to be considered as extra, but rather as integral elements of street design. The appropriate response is to treat complete streets exactly like any transportation project.

Act 34 does not require a community to upgrade the street system to “complete” standards. What it does require is that if major reconstruction or street improvements are undertaken, they consider and, to the extent feasible, incorporate complete streets design principles into the project. Act 34 is a design approach and not a program that needs to be funded. Complete streets projects should be funded exactly the way all roadway projects have been funded: through the community’s capital budgeting process for local projects and through the TIP/STIP funding process for projects with state or federal funding.

VTrans has made cost data available for many types of bicycle and pedestrian projects in a [report](#) available at their website.

### Consider the Alternatives

Act 34 allows exemptions in cases where the probable use is disproportionate to the cost of providing a complete street design. There may often be some projects that would pose very high costs, either financial or environmental, which may

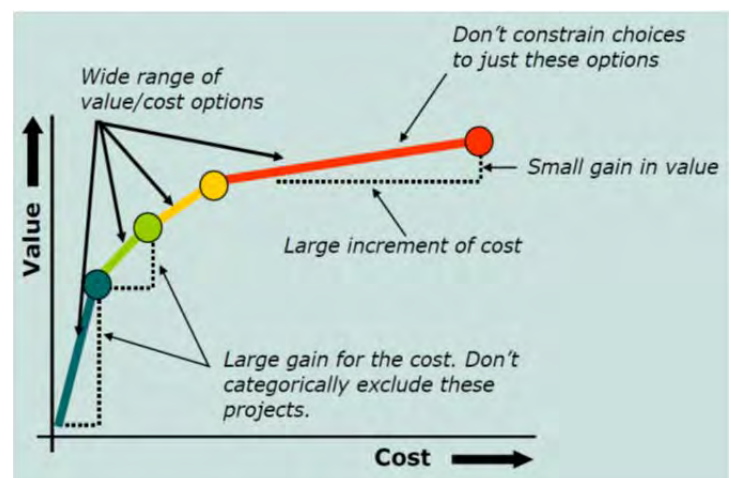



make them less feasible. In that case, a concerted effort should be made to find lower cost alternatives that may have at least some complete street benefits, even if the resulting project is not truly “complete” for all users. The chart above illustrates the importance of considering a wide range of values (or benefits) in relation to costs, which can allow the community to select the right level of investment that will address the needs and likely use. In these financially constrained times, the high cost/high value option may not often be practical, but there are usually other measures or alternatives that would have some incremental benefits.

### Determine Probable Use

The other variable to consider is the probable use. The mere lack of pedestrians (or bicyclists) on a particular road or street does not in itself mean that there is no demand for these modes, but rather reflects an unsafe or undesirable environment, which influences people’s choice of modes. The projected bicycle and pedestrian use should be determined by both a review of traffic count data (which now typically include bicycles and pedestrians), a review of any transit services, and consideration of land use patterns that may generate pedestrian travel. Mixed land uses in close proximity and at higher density will generate numerous short trips, many of which could be walking or biking if the environment supports them. Urban transect zones (C3-C6) should accommodate pedestrian travel, and particularly warrant complete streets design. VTrans identifies a number of additional considerations in its guidance for determining probable use by non-auto users:

- Consult both existing conditions and future plans; the transportation facility often lasts longer than adjacent buildings and land uses.
- Review local and regional plans, zoning codes, corridor plans or mode specific plans (e.g., bike/pedestrian master plan or transit plan).
- Evaluate residential densities and proximity of residential areas to nearby schools, recreational facilities, government services or places of employment.
- Consider land uses that serve vulnerable populations, such as schools or senior housing.

### Consider the Costs

The following table provides a summary of the range of potential complete street tools and project elements, and a rough indicator of relative cost. In order to consider the costs and benefits, communities should consider a wide range of tools such as those listed here. While the most “complete” project may not be within the financial reach of a community, there may be some options that would have some benefit in proportion to the cost.

Category	Action	Cost
Vehicular Way	Restripe lanes within existing constructed roadway	\$
	Reconstruct roadway: narrow curb-to-curb width or add facilities (e.g., parking, bike lanes)	\$\$\$
	Reconstruct roadway: add median	\$\$\$
	Road diets	\$-\$\$\$
	Add paved shoulder to rural roadway sections to support bicycle and/or pedestrian traffic	\$\$-\$\$\$\$
Sidewalks	Construct new sidewalk/reconstruct (& widen) existing	\$\$-\$\$\$
	Pedestrian amenities (e.g., benches, wayfinding)	\$\$
Crosswalks and Pedestrian Signals (intersection or mid-block)	Stripe and sign crosswalk	\$
	Enhanced warning (e.g., RRFB-Rapid Rectangular Flashing Beacon)	\$
	Full signal control (e.g., HAWK – High Intensity Activated Crosswalk)	\$\$
	Add pedestrian refuge island	\$\$-\$\$\$

Bicycle Facilities	Define bicycle route with shared lane marking and signage	\$
	Define bicycle lanes with striping, markings and signage	\$-\$\$
	Construct multi-use path	\$\$\$
	Add bicycle amenities (e.g., racks, lockers) at key destinations	\$\$
Transit	Transit stop with sign	\$
	Transit stop with shelter, access pad(s), etc	\$\$
	Transit stop with pullout or bulbout	\$\$
	Add maps & schedules to stops	\$
	Active arrival system	\$\$\$
	Add bicycle racks to buses	\$
Intersections	Reconstruct intersection with tighter curb return radii	\$\$ - \$\$\$
	Reconstruct slip lane with better angle for pedestrians	\$\$-\$\$\$
	Reconstruct intersection with curb extensions	\$\$\$
	Signalize	\$\$-\$\$\$
	Retime signal with Leading Pedestrian Interval (LPI)	\$
	Reconstruct intersection with modern roundabout	\$\$\$
On-street Parking	Stripe on-street parking within existing roadway	\$
	Add metering or point pay metered parking	\$\$-\$\$\$
Streetscape Improvements	Street Trees and Street Furniture, Lighting	\$\$-\$\$\$
Access Management	Reconstruct roadway to consolidate accesses, define driveway(s)	\$\$\$
	Reconstruct driveway(s) to improve sidewalk functionality	\$\$
	Add median to primary roadway to control left turns	\$\$\$

## 7) Documentation, Reporting and Maintenance

Act 34 requires that municipalities maintain and disseminate information relative to the complete streets status of all qualifying projects. VTrans has established its own internal reporting protocol including forms and procedures. This guide recommends that a reporting system that reflects the planning process outlined herein be conducted at the municipal level. Reporting forms for municipal projects are included in the Appendix.

# Complete Streets References

Page	Resource and Link
1	FHWA “Complete Streets,” <a href="http://www.fhwa.dot.gov/publications/publicroads/10julaug/03.cfm">http://www.fhwa.dot.gov/publications/publicroads/10julaug/03.cfm</a>
1	National Complete Streets Coalition, <a href="http://www.completestreets.org/">http://www.completestreets.org/</a>
1	AARP Public Policy Institute Report, <a href="http://assets.aarp.org/rgcenter/ppi/liv-com/2009-12-streets.pdf">http://assets.aarp.org/rgcenter/ppi/liv-com/2009-12-streets.pdf</a>
1	Complete text of Act 34 can be found at: <a href="http://www.leg.state.vt.us/docs/2012/Acts/ACT034.pdf">http://www.leg.state.vt.us/docs/2012/Acts/ACT034.pdf</a>
2	VTrans Complete Streets Guidance March 2012, p.3, <a href="http://www.aot.state.vt.us/ProgDev/Publications/DocumentsPUBLICATIONS/HSDEI%2012-001%20-%20Complete%20Streets%20Guidance.pdf">http://www.aot.state.vt.us/ProgDev/Publications/DocumentsPUBLICATIONS/HSDEI%2012-001%20-%20Complete%20Streets%20Guidance.pdf</a>
3	Burlington Transportation Plan, <a href="http://www.burlingtonvt.gov/DPW/Transportation/Policy-and-Planning/Transportation-Plan/">http://www.burlingtonvt.gov/DPW/Transportation/Policy-and-Planning/Transportation-Plan/</a>
5	VTrans Project Development Manual <a href="http://www.aot.state.vt.us/progdev/Publications/PDManual/01mantabl.htm">http://www.aot.state.vt.us/progdev/Publications/PDManual/01mantabl.htm</a>
5	VTrans LTF Publications: <a href="http://www.aot.state.vt.us/progdev/Sections/PublicationsOverview62011.htm">http://www.aot.state.vt.us/progdev/Sections/PublicationsOverview62011.htm</a>
6	Vermont State Design Standards: <a href="http://www.aot.state.vt.us/progdev/standards/statabta.htm">http://www.aot.state.vt.us/progdev/standards/statabta.htm</a>
6	ITE Context Sensitive Solutions Website: <a href="http://www.ite.org/css/default.asp">http://www.ite.org/css/default.asp</a>
6	Center for Applied Transect Studies (Urban-to-Rural Transect): <a href="http://www.transect.org/">http://www.transect.org/</a>
11	VTrans Right of Way Section: <a href="http://www.aot.state.vt.us/progdev/Sections/RightofWay62011.htm">http://www.aot.state.vt.us/progdev/Sections/RightofWay62011.htm</a>
11	Literature Review on Vehicle Speeds and Pedestrian Injuries., Leaf, W. and D. Preusser, Washington, DC, US Dept of Transportation(1999). <a href="http://www.nhtsa.gov/people/injury/research/pub/HS809012.html">http://www.nhtsa.gov/people/injury/research/pub/HS809012.html</a>
11	VTrans Traffic Count Data: <a href="http://www.aot.state.vt.us/planning/TrafResearch/trafficrosearch.htm">http://www.aot.state.vt.us/planning/TrafResearch/trafficrosearch.htm</a>
11	Vermont Regional Planning Commissions, <a href="http://www.aot.state.vt.us/planning/RPCpage.htm">http://www.aot.state.vt.us/planning/RPCpage.htm</a>
12	VTrans Crash Data: <a href="http://www.aot.state.vt.us/planning/HighResearch/highwayresearch.htm">http://www.aot.state.vt.us/planning/HighResearch/highwayresearch.htm</a>
12	Pedestrian Road Safety Audit and Prompt List, <a href="http://www.walkinginfo.org/library/details.cfm?id=3955">http://www.walkinginfo.org/library/details.cfm?id=3955</a>
12	Bicycle Road Safety Audit and Prompt List, <a href="http://safety.fhwa.dot.gov/ped_bike/tools_solve/fhwasa12018/">http://safety.fhwa.dot.gov/ped_bike/tools_solve/fhwasa12018/</a>
12	VTrans LTF Guidebook: <a href="http://www.aot.state.vt.us/progdev/Sections/LTF%20Info/LTFGuidebookMunicProj62011.htm">http://www.aot.state.vt.us/progdev/Sections/LTF%20Info/LTFGuidebookMunicProj62011.htm</a>
15	Pennsylvania Smart Transportation Guidebook, <a href="http://www.smart-transportation.com/guidebook.html">http://www.smart-transportation.com/guidebook.html</a>
15	ITE CSS Fact Sheet, <i>Factors to Control Speed</i> , <a href="http://www.ite.org/css/FactSheet3.pdf">http://www.ite.org/css/FactSheet3.pdf</a>
15	Pedestrian Safety and Speed, <a href="http://www.walkinginfo.org/pedsafe/crashstats.cfm">http://www.walkinginfo.org/pedsafe/crashstats.cfm</a>

15	TRB Report on Urban Roadside Safety, NCHRP 612: <a href="http://www.trb.org/Main/Public/Blurbs/160176.aspx">http://www.trb.org/Main/Public/Blurbs/160176.aspx</a>
15	NCHRP, Safe and Aesthetic Design of Roadside Treatments, <a href="http://www.trb.org/Main/Public/Blurbs/160176.aspx">http://www.trb.org/Main/Public/Blurbs/160176.aspx</a>
19	North American City Transportation Officials (NACTO) Bicycle Design Guide: <a href="http://nacto.org/cities-for-cycling/design-guide/">http://nacto.org/cities-for-cycling/design-guide/</a>
19	The Vermont Pedestrian and Bicycle Facilities Planning and Design Manual (VPBFPDM): <a href="http://www.aot.state.vt.us/progdev/Publications/DocumentsPUBLICATIONS/PedestrianandBicycleFacilityDesignManual.pdf">http://www.aot.state.vt.us/progdev/Publications/DocumentsPUBLICATIONS/PedestrianandBicycleFacilityDesignManual.pdf</a>
24	VTrans Landscape Guide, <a href="http://www.aot.state.vt.us/progdev/Publications/DocumentsPUBLICATIONS/VTrans_Landscape_Guide.pdf">http://www.aot.state.vt.us/progdev/Publications/DocumentsPUBLICATIONS/VTrans_Landscape_Guide.pdf</a>
24	<i>Outdoor Lighting</i> Guide for Vermont Municipalities, <a href="http://www.ccrpcvt.org/land_use/vt_outdoor_lighting_manual_1996.pdf">http://www.ccrpcvt.org/land_use/vt_outdoor_lighting_manual_1996.pdf</a>
24	Efficiency Vermont-Energy efficient fixtures: <a href="http://efficiencyvermont.com/Index.aspx">http://efficiencyvermont.com/Index.aspx</a>
24	IESNA (Illuminating Engineering Society of North America). <a href="http://webstore.ansi.org">http://webstore.ansi.org</a> . (Search the web store for document ANSI/IESNA RP-8-00, Roadway Lighting 2005)
26	Access management, <a href="http://www.smartgrowthvermont.org/toolbox/tools/accessmanagement/">http://www.smartgrowthvermont.org/toolbox/tools/accessmanagement/</a>
30	FHWA Roundabouts: <a href="http://safety.fhwa.dot.gov/intersection/roundabouts/#tech">http://safety.fhwa.dot.gov/intersection/roundabouts/#tech</a>
30	New Hampshire Roundabout Website (NH DOT): <a href="http://www.nh.gov/dot/org/projectdevelopment/highwaydesign/roundabouts/index.htm">http://www.nh.gov/dot/org/projectdevelopment/highwaydesign/roundabouts/index.htm</a>
30	Victoria Transport Policy Institute: <a href="http://www.vtpi.org/walkability.pdf">http://www.vtpi.org/walkability.pdf</a>
31	Report on the unit costs of Vermont Bike/Ped Projects, <a href="http://www.aot.state.vt.us/progdev/Sections/LTF%20Info/DocumentsLTFPages/BikePedReport%20on%20Shared%20Use%20Path%20and%20Sidewalk%20Unit%20Costs_2010_FINAL813.pdf">http://www.aot.state.vt.us/progdev/Sections/LTF%20Info/DocumentsLTFPages/BikePedReport%20on%20Shared%20Use%20Path%20and%20Sidewalk%20Unit%20Costs_2010_FINAL813.pdf</a>



# Appendix

## Performance Measures

An effective means of gauging the success of a community's complete streets program is a foundation of the entire process. The National Complete Streets Coalition (NCSC) cites the inclusion of "measures of effectiveness" (MoEs) as one of its ten criteria for assessing the value of a local or regional (or even state-wide) complete streets policy. The choice and construction of actual MoEs, however, is a bit more complicated. The NCSC cites the following as possible measures:

- a. Total miles of on-street bicycle routes defined by streets with clearly marked or signed bicycle accommodation
- b. Linear feet of new pedestrian accommodation
- c. Number of new curb ramps installed along city streets
- d. Number of new street trees planted along city streets

Additionally, for its Pedestrian and Bicycle Policy Plan, VTrans has developed a list of performance measures (a term roughly synonymous with measures of effectiveness) that offers at least a point of departure for localities undertaking complete streets programs. VTrans itself recognizes that some of these measures include potentially difficult data collection, and that they are more oriented toward use than facilities. While it is true that part of the goal of complete streets initiatives is increased use of non-auto modes, most programs have more of a facilities orientation.

For municipal purposes a modified subset of these measures are recommended:

- The "Usage" measures require data that are difficult to acquire (e.g., minutes of walking/biking per day). If communities wanted to undertake periodic counts of pedestrian and/or biking activity at key locations, or conduct surveys of how children arrive at school, for example, these could be very helpful in their overall assessment of these important contributors to community livability.
- "Safety" is a key variable and can be included. Data on the number of injuries or fatalities of bicycles and pedestrians is available from VTrans.
- The "Facilities" measures are relevant and easier to implement, and reflect the above NCSC measures.
- "Training and Assistance" can be measured by participation of staff and board members in training of complete streets principles. In addition to local public works staff and road crews, planning and zoning staff and boards, selectboards and council members should participate.

Some ideas for additional facilities measures that link directly to complete streets implementation are offered below:

- % of residences served directly by walkway(s) or paths
- % of jobs served directly by walkway(s) or paths
- % of residences/business jobs accessible to transit (within ½ mile)
- % of intersections on high volume roads with pedestrian crossings
- % eligible road miles supporting bicycles (bike lane/path, paved shoulder, shared lanes on slow streets)

Most of these measures have the advantage of being relatively easy to obtain, either directly from GIS maps or from direct observation and measurement. No special surveys or data sources are required.

## Maintenance

VTrans devotes an entire chapter to maintenance in the Vermont Pedestrian and Bicycle Facility Planning and Design Manual, which offers excellent guidance for maintenance of complete streets. The importance of adequate maintenance to complete streets functionality cannot be overemphasized. Pedestrians and bicyclists are highly vulnerable to the elements; the pothole that is annoying to a driver can be catastrophic to the bicyclist, and the puddle of slush that a driver barely notices is a major obstacle to a pedestrian and potentially un-traversable for an elderly person, especially when frozen in the winter. A few of the principles for maintaining bicycle and pedestrian friendly streets in a cost-effective manner are summarized below.

Low Maintenance By Design: Good maintenance begins with the conception and design of the facility. The following considerations can contribute to good maintenance before a facility is even constructed:

- Use common sense and keep the design simple.
- Expect vandalism, and plan to have “eyes on the street” by locating in sight of businesses and neighbors.
- Use durable, locally available materials where possible to ease and speed repair and replacement.
- Avoid mechanical parts that may rust, corrode, loosen or break.

Management Plans: Develop written maintenance procedures and checklists to ensure adequate maintenance and repair of facilities.

Snow Removal: In a complete streets approach, snow clearance from walkways should be considered on an equal priority with roadway plowing. Snow impedes walking and bicycling far more than it does driving, especially for elderly or disabled persons. It is often not only the initial snow event that covers walk and bike-ways, but subsequent street plowings can cover sidewalks with several inches of slush that will freeze into a difficult and dangerous surface. When designing sidewalks, consider the benefits of a greenbelt between the road’s edge and the sidewalk for snow storage.

Keep Street Clean: Debris, including loose stones, twigs, limbs, and leaves, impede both bicycle and pedestrian circulation, and can sometimes be dangerous for bicyclists. Standing water or ice is a significant impediment to both pedestrian and bicycle access. Street sweeping should be conducted annually, preferably in the spring to clear off winter sand. Drainage features must be kept free of debris, and oriented so as not to be bicycle wheel traps.

Surface maintenance and repairs: The quality of the surface is more important to walkers and bikers than to vehicles. Potholes that one would barely notice in an auto can be catastrophic to bicycles and force them to suddenly veer into the adjacent traffic lane. Significant unevenness in walkways is awkward and impeding for most pedestrians, and can be all but insurmountable to the elderly and disabled. Providing adequate base materials will help to increase the longevity of paved surfaces. Resurfacing projects require that utility covers, grates and shoulders be adjusted so that they are maintained at an even level. Utility cuts must be back filled and paved appropriately, recognizing settlement, to maintain an even surface.

Signs and markings: These also require periodic inspection and maintenance. Of particular importance are crosswalk markings, which often must be repainted annually, depending on the vehicle wear they receive.

Vegetation: Roadsides must be mowed and maintained regularly, both to provide a refuge for a pedestrian on a narrow roadway as well as for visibility. Landscape plantings should be designed to minimize encroachment into the traveled ways.

Transit Considerations: Transit stops should be maintained regularly, including clearing snow, ice and other obstacles, and vandalism of transit shelters should be repaired.

## Reporting Forms

The following pages provide a reporting form for complete streets projects that are offered for use by municipalities.

## Complete Streets Project Reporting Form

Town/City of \_\_\_\_\_

This project reporting form and attached checklist can serve to document that Complete Streets practices and principles were considered and implemented where appropriate for the project listed below. This form should be completed after preliminary plans and retained in the project file.

Project Name: \_\_\_\_\_

Project Number: \_\_\_\_\_

Date: \_\_\_\_\_

Attach completed checklist

### Complete Streets Exemptions:

Is the use of the transportation facility by pedestrians, bicyclists, or others users prohibited by law? Y / N

Is the cost of including complete streets principles disproportionate to the need or probable use? Y / N

Are complete streets principles outside the scope of the subject project because of its very nature? Y / N

Supporting documentation can be attached to this document and retained in the project's file. For all other instances a brief description of the Complete Streets practices and principles that have been incorporated into the subject project's design can be included below.

Describe Complete Streets elements included in project: \_\_\_\_\_

---

---

---

---

---

---

---

---



## Complete Streets - Municipal Planning/Scoping Project Checklist

### Obtain the Municipal/Regional Plan(s)

- Determine multi-modal status of subject facility per plan(s) recommendations

### Determine Land Use Context

- Ascertain land use type & density: existing; future/desired
- Determine context zone: existing; future/desired

### Identify Current Transportation Modes and Facilities; Transportation Data

- Determine roadway classification: existing; future/desired
- Determine pedestrian and bicycle facilities: existing; future/desired
- Identify existing and projected transit service features
- Obtain current and projected traffic volumes
- Identify current and projected pedestrian/bicyclist use
- Obtain existing crash data (including pedestrian and bicycle crashes)

### Identify Constraints on Transportation Project Development

- Determine existing roadway right-of-way
- Determine location of traveled way within right-of-way
- Assess potentially available private front yard space
- Identify existing natural resource constraints
- Identify existing historic resource constraints

### Other Factors (explain any that apply)

- Environment \_\_\_\_\_
- Economic development \_\_\_\_\_
- Aesthetics \_\_\_\_\_
- Historic preservation \_\_\_\_\_
- Health \_\_\_\_\_

### Describe Alternatives Considered

---

---

### Describe Preferred Alternative and Indicate complete streets elements in final recommendation

---

---